

Profile

- Solid shaft \varnothing 4 mm or \varnothing 6 mm
- Adaptation to various measurement distances owing to a wide range of gear ratios
- Integrated slip clutch to protect the potentiometer
- Compact design
- Potentiometer, power or voltage output
- IP65 protection class

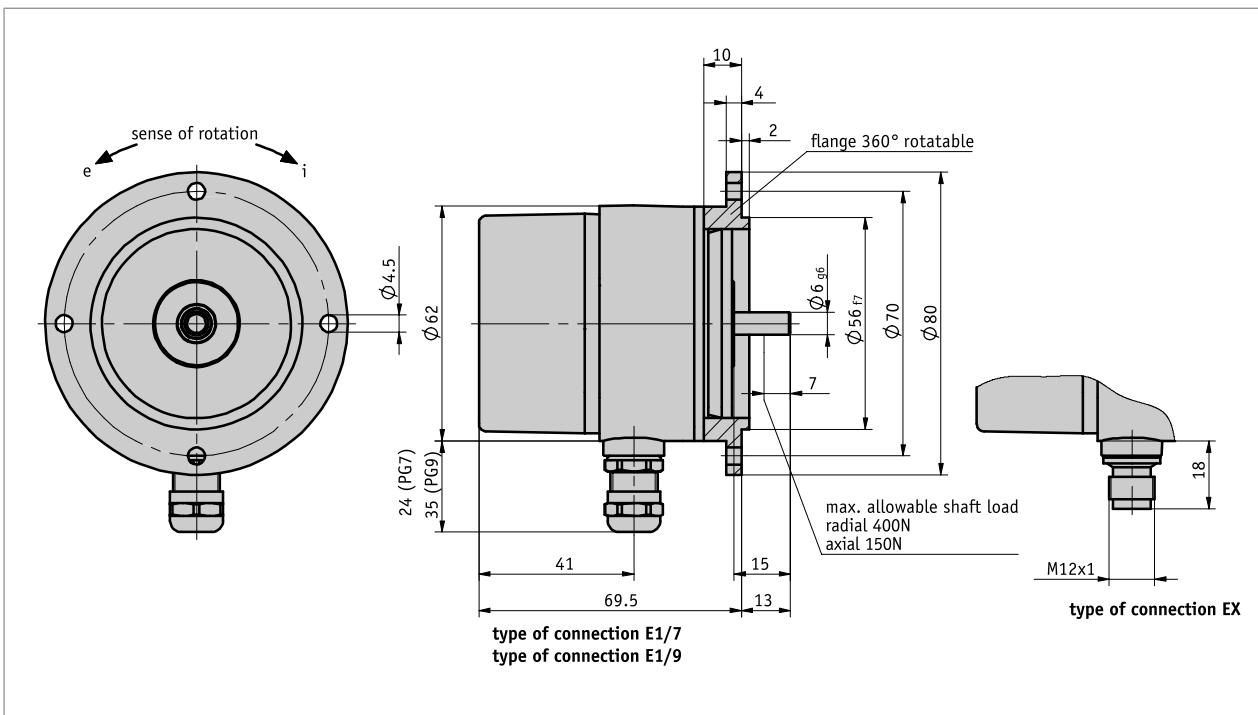

Mechanical data

Feature	Technical data	Additional information
shaft	rustproof stainless steel	
Housing	reinforced plastic / aluminum	
Gear ratio	0.2 ... 256	
Speed	≤ 500 min ⁻¹	depending on transmission
Shaft load rating	≤ 400 N	radial
	≤ 150 N	axial
Potentiometer service life	1×10^6 rotation(s)	

Electrical data

■ Encoder potentiometer type 01,1 helix

Feature	Technical data	Additional information
Power rating	1 W at 70 °C	≤30 V
resistance	5, 10 kΩ	
Resistance tolerance	±10 %	
Standard terminal resistance	0.5 %	
Linearity tolerance	±1 %	
Design	hybride	

■ Encoder potentiometer type 02,10 helices

Feature	Technical data	Additional information
Power rating	2 W at 70 °C	≤30 V
resistance	1, 5, 10 kΩ	
Resistance tolerance	±5 %	
Standard terminal resistance	0.5 %	
Linearity tolerance	±0.25 %	
Design	wire	

■ Encoder potentiometer type 03, 10 helices

Feature	Technical data	Additional information
Power rating	2 W at 70 °C	≤30 V
resistance	1, 5, 10 kΩ	
Resistance tolerance	±5 %	
Standard terminal resistance	0.5 %	
Linearity tolerance	±0.25 %	
Design	hybride	

■ Transducer, power output

Feature	Technical data	Additional information
Operating voltage	24 V DC ±20 %	
Output current	4 ... 20 mA at load 500 Ω	

■ Transducer, voltage output

Feature	Technical data	Additional information
Operating voltage	24 V DC ±20 %	
Output voltage	0 ... 10 V	

System data

Feature	Technical data	Additional information
Measuring range	340° ±5°, (mechanical full-length)	potentiometer type 01
	3600° +10°	potentiometer types 02, 03

Ambient conditions

Feature	Technical data	Additional information
Ambient temperature	-20 ... 80 °C	
Relative humidity		condensation inadmissible
EMC	EN 61000-6-2	interference resistance / immission
	EN 61000-6-4	emitted interference / emission
Protection category	IP65	EN 60529

pin assignment

■ without transducer

Signal	Terminal E1	PIN EX
Pe	1	1
Po	2	2
S	3	3
nc	-	4

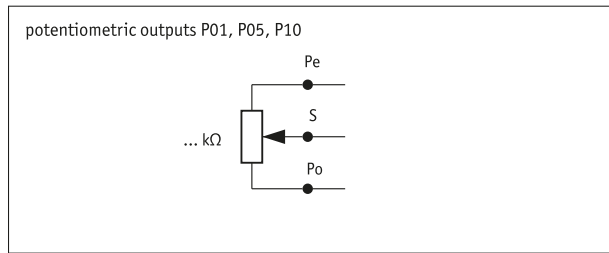

■ MWI transducer

Signal	Terminal E1	PIN EX
I+	1	1
I-	2	2
nc	3	3
nc	-	4

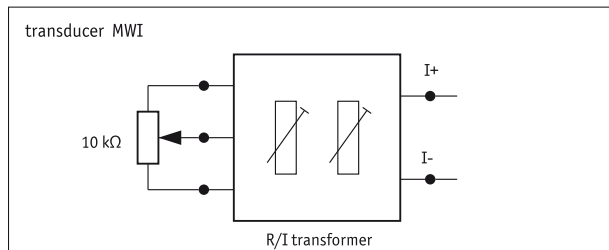

■ MWU transducer

Signal	Terminal E1	PIN EX
+24 V DC	1	1
GND	2	2
Uout	3	3
nc	-	4

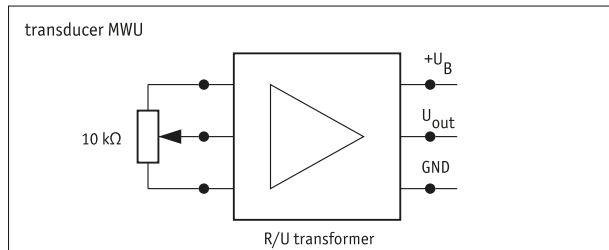

Order

■ Gear ratio calculation

$$\text{Formula: } i_1 = \frac{n \times 360^\circ}{\alpha}$$

n = number of revolutions on the driving shaft
 α = potentiometer angle of rotation
 340° with 1-coil potentiometer
 3600° with 10-coil potentiometer
 i_1 = order feature for gear ratio

If the calculated ratio "i1" is the same as a value in the ordering table for the "ratio" feature, but this is not available, select the next highest ratio.



■ Ordering table

Feature	Ordering data	Spezifikation	Additional information
Gear ratio	A ...	0.1, 0.166, 0.25, 0.333, 0.5, 1, 2, 3, 4, 5, 6, 7, 10, 12, 15, 20, 24, 30, 40, 55 others on request	
Type of connection	B E1/7 E1/9 EX	PG7 cable gland PG9 cable gland M12 plug	
potentiometer type	C 01 02 03	1 helix, hybrid 10 helices, hybrid 10 helices, wire	only for P05 or P10 analog output
analog output	D MWI	transducer 4 ... 20 mA	

Feature	Ordering data	Spezifikation	Additional information
	MWU	transducer 0 ... 10 V	
	P01	potentiometer 1 kΩ	
	P05	Potentiometer 5 kΩ	
	P10	potentiometer 10 kΩ	
Sense of rotation	E	no information required	only for P01, P05, or P10 analog output
	e	counter-clockwise ascending values	only for MWI or MWU analog output
	i	clockwise ascending values	only for MWI or MWU analog output

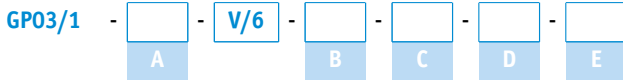
■ **Order key**



	<p>Scope of delivery: GP03/1, Installation Instructions</p>
	<p>Accessories you can find: Flexible coupling AK18 Servo clamp SK Overview Mating connector Mating connector, 4-pole, socket</p> <p style="text-align: right; font-size: small;"> www.siko-global.com www.siko-global.com www.siko-global.com Order key 83419 </p>