

AP10

Absolute Position Indicator with  IO-Link interface

User manual

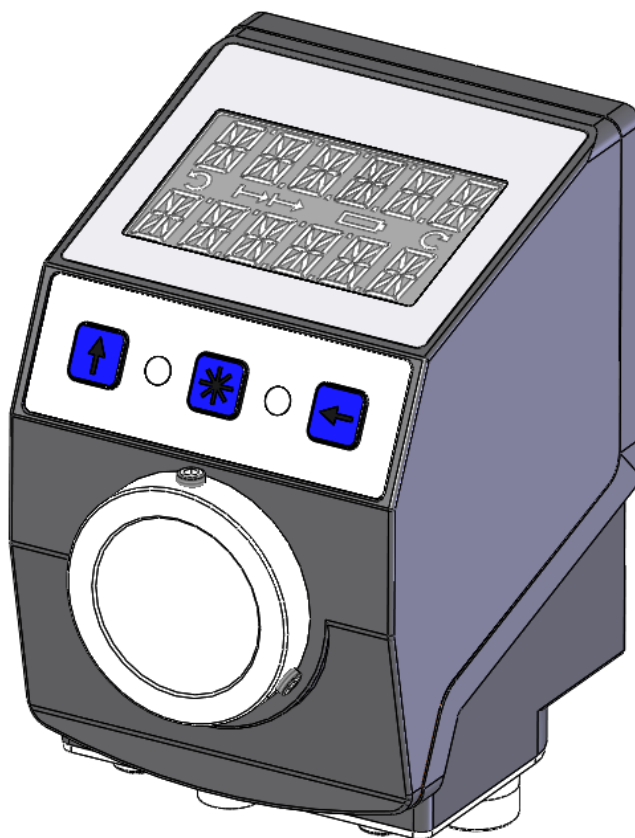

Table of contents

1	General Information	5
1.1	Documentation	5
1.1.1	History	5
1.2	Definitions	5
1.3	Intended use	5
1.4	Switching on the operating voltage.....	6
2	Display and control elements.....	6
2.1	LCD display.....	7
2.1.1	Extended display range	7
2.2	LED display.....	7
2.2.1	Device status.....	7
2.3	Control keys.....	8
2.3.1	Key lock and enable time	8
3	Functional Description	8
3.1	Operating modes	8
3.1.1	Absolute position operating mode	8
3.1.1.1	Positioning.....	8
3.1.1.2	Loop positioning	9
3.1.1.3	ControlWord in Absolute Position operating mode	10
3.1.1.4	StatusWord in Absolute Position operating mode	11
3.1.2	Alpha-numeric display operating mode.....	12
3.1.2.1	ControlWord: Alpha-numeric display	12
3.1.2.2	StatusWord: Alpha-numeric display	13
3.2	Battery buffering.....	14
3.3	Parameterization of the position indicator	14
3.3.1	Manual parameterization	14
3.3.1.1	Starting parameterization	14
3.3.1.2	Value input.....	15
3.3.1.3	Value selection.....	15
3.3.1.4	Overview of the operating menu	16
3.3.1.5	"Changeable parameters" menu	16
3.3.1.6	Positioning.....	17
3.3.1.7	Visualization.....	17
3.3.1.8	LED function.....	17
3.3.1.9	Device options	18
3.3.2	Parameterization via interface	18
3.4	Calibration	18
3.5	Additional functions	18
3.5.1	Device data	18
3.5.2	Restore factory settings	19
3.6	Warnings / Errors.....	19

3.6.1	Warnings	19
3.6.2	Errors	19
3.6.3	Corrective actions	20
4	Parameter	20
4.1	Process data	20
4.1.1	ControlWord	20
4.1.2	StatusWord	21
4.1.3	TargetValue.....	21
4.1.4	ActualValue.....	21
4.1.5	DisplayData.....	22
4.1.6	TargetValueLeft.....	22
4.2	Positioning.....	23
4.2.1	Resolution	23
4.2.2	DecimalPlaces.....	23
4.2.3	DisplayDivisor.....	24
4.2.4	CountingDirection	24
4.2.5	CalibrationValue.....	25
4.2.6	TargetWindow.....	25
4.2.7	LoopType	26
4.2.8	LoopLength.....	26
4.3	Visualization.....	27
4.3.1	DisplayOrientation	27
4.4	LEDs	27
4.4.1	LEDMode.....	27
4.4.2	Led1GreenMode	28
4.4.3	Led2GreenMode	28
4.4.4	Led1RedMode	29
4.4.5	Led2RedMode	29
4.4.6	ActiveLedsFlashing.....	30
4.5	Device options	30
4.5.1	KeyEnableTime.....	30
4.5.2	KeyCalibration	31
4.5.3	KeyIncremental.....	31
4.5.4	OperatingMode	32
4.5.5	SensorType.....	32
4.5.6	PINChange	33
4.5.7	LoadDefault.....	33
4.5.8	CODE.....	33
5	I0-Link	34
5.1	Process data input / output	34
5.1.1	Process data in Absolute position operating mode	35
5.1.1.1	Process data output (master ⇒ device)	35
5.1.1.2	Process data input (device ⇒ master).....	36

5.1.2	Process data in Alphanumeric display operating mode	37
5.1.2.1	Process data output (master ⇒ device)	37
5.1.2.2	Process data input (device ⇒ master)	38
5.2	Directory of objects	39
5.2.1	IO-Link specific objects.....	39
5.3	SystemCommands	40
5.4	DeviceAccessLocks	40
5.5	EventCodes	40
5.6	ErrorCodes	41
6	Block diagram	41

1 General Information

1.1 Documentation

The following documents describe this product:

- The data sheet describes the technical data, the dimensions, the pin assignment, the accessories and the order key.
- The installation instructions describe the mechanical and electrical installation with all safety-relevant conditions and the associated technical specifications.
- User manual for connecting the display to an IO-Link master and for commissioning.
- IODD file (IO-Link Device Description); with the help of this file, the connection and configuration with an IO-Link master is possible by means of commercially available IO-Link masters and their configurators.

You can also download these documents at <http://www.siko-global.com/p/ap10>.

1.1.1 History

Mod. status	Date	Description
102/22	16.05.2022	from firmware V3.01 Chapter 5.1.1 Process data in Absolute position operating mode add text, text swapped in columns Chapter 5.1.2 Process data in Alphanumeric display operating mode add text, text swapped in columns

1.2 Definitions

If not explicitly stated otherwise, decimal values are given as figures without an extension (e. g. 1234), binary values are marked after the figure with a "b" (e. g. 1011b), hexadecimal values with an "h" (e. g. 280h).

1.3 Intended use

Unless otherwise described, normal operation of the system with unchanged factory setting is assumed for the further description of functions.

The present device is an absolute position indicator with integrated IO-Link interface and a hollow shaft for direct shaft mounting. Indicators, control buttons and interface are only active with external power supply. The sensor of measurement encoder works magnetically incrementally. Without an external power supply, encoder changes are recorded with battery support. The status of the replaceable battery is monitored. A volatile TargetValue can be displayed below the ActualValue via the backlit two-line LC display A direction display (indicator) is displayed if there is a deviation between the actual value and the target window (target value including TargetWindow parameter). The arrow direction indicates in which direction the shaft must be rotated to reach the target window. In addition, the position status of two two-color LEDs (green and red) is displayed. Device malfunctions or inadmissible operating conditions are displayed.

The buttons can be used to select various functions and to adapt the device parameters of the application stored in non-volatile memory. The actual value can be queried via the interface, the target value can be changed and all device parameters can be adjusted.

1.4 Switching on the operating voltage

The AP10 will be initialized after switching on the supply voltage. A system and display test is executed during initialization, the LEDs are lighted consecutively and the parameters are loaded from the non-volatile memory into the RAM of the controller.

At first use, the default values are used during initialization. After the return of the external power supply or software reset (warm start), the AP10 works with the last saved parameters. If no fault has been detected, the AP10 starts normal operation and can communicate with an IO-Link Master.

2 Display and control elements

The position indicator has a two-line display with special characters and three control keys. The actuator can be configured and controlled via the keys.

Two LEDs (LED1, LED2) serve for monitoring positioning.

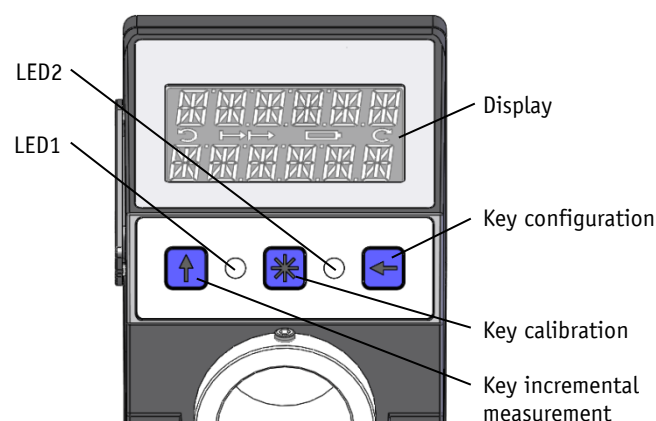



Fig. 1: Display and control elements

2.1 LCD display

NOTICE	The display range is limited to -199999 ... 999999. Values outside this range are displayed with "FULL".
---------------	--

When the operating voltage is applied, the actual value (absolute position value, ActualValue) is displayed in the first line. If there is no valid target value, "----" appears in the second line. If a target value is declared valid by means of the control bit in the process data (see e. g. [bc09_TargetValueActive](#)), this is displayed in the 2nd line. The values displayed are determined by the operating mode.

Direction indicators (arrows) support positioning.

The battery symbol  is shown with a critical or insufficient battery status. If battery voltage drops to a critical value, the battery symbol on the display will flash. If it falls below the minimum value, the symbol will glow permanently.

With incremental measurement function activated, the incremental measurement symbol  is shown.

This is signaled in red letters in the event of a fault.

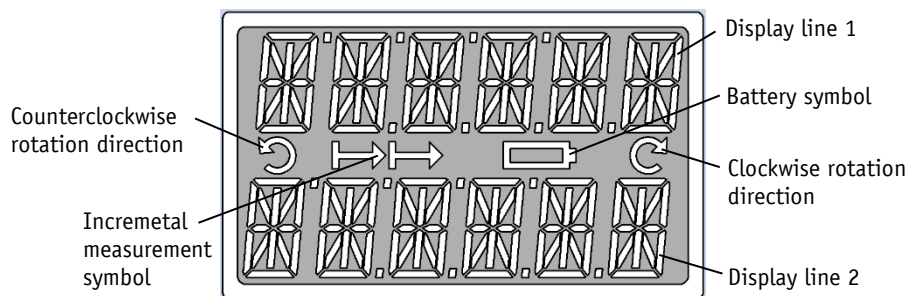

Fig. 2: Two-line 14 segment LCD display

2.1.1 Extended display range

Values up to -199999 can be displayed by means of the ControlWords (see [bc03_DisplayRange](#)). If the relevant bit has been set and the value to be displayed is between -199999 and -999999, then the negative sign and the digit of the highest order will flash alternately. If the value range drops below -999999, "FULL" will be displayed.

2.2 LED display

2.2.1 Device status

NOTICE	A test sequence is executed on these LEDs during initialization.
---------------	--

In its basic state (factory setting) the LED display has different meanings depending on the operating mode (see chapter [3.1](#)).

In order for LED1 or LED2 to be controlled via the ControlWord, this function of the LEDs must be activated by means of parameters (see chapter [3.1.1.3](#), [3.1.2.1](#), [4.4](#) and [5.1](#)).

2.3 Control keys

Pressing  the Incremental button switches the increment function or a relative measurement on or off.

Pressing  the Calibration button starts the calibration and acknowledges an existing fault. In the "Alphanumeric display" operating mode, the receipt of a target value is acknowledged by this action.

Pressing  the Configuration button starts the parameterization.

See also chapter 3.3.1 and Fig. 1.

2.3.1 Key lock and enable time

The key access to the chain dimension function and calibration can be generally blocked with the parameters KeyCalibration and KeyIncremental (see chapter 4.5.2). The time during which the button  must be pressed until you can enter the menu can be set in the Options menu. Access via keys to the changeable device parameters can only be obtained after entering the PIN. This can be defined using the parameter PINChange (see chapter 4.5.6).

3 Functional Description

3.1 Operating modes

The following position-dependent operating modes are differentiated: **Absolute position** and the position-independent operating mode **Alpha-numeric display**.

Operating mode	Absolute position	Alpha-numeric Display
Line 1	Actual value (ActualValue)	Target value 1 (DisplayData)
Line 2	Target value (TargetValue)	Target value 2 (TargetValue)

Table 1: Display with different operating modes

3.1.1 Absolute position operating mode

The measured absolute position value is calculated depending on the parameters [Resolution](#), [DisplayDivisor](#) and [DecimalPlaces](#) and displayed as actual value. The actual value ([ActualValue](#)) of higher-level control can be provided via the interface and a target value can be set as a default. The target value must be set to valid in the ControlWord ([bc09_TargetValueActive](#)).

3.1.1.1 Positioning

Target window:

A target window is formed to be able to define a tolerance range.

Target window = [TargetValue](#) ± [TargetWindow](#)

Example Position monitoring:

TargetWindow = 5
 TargetValue = 100

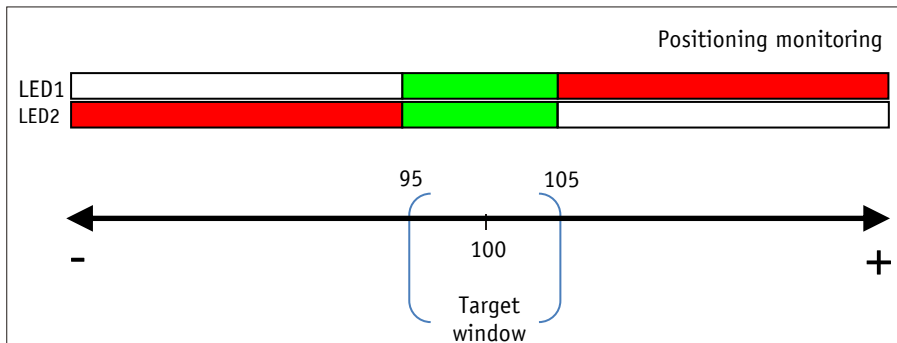

Fig. 3: Positioning monitoring with TargetWindow

Directional arrows:

To assist in positioning, direction arrows are displayed in the display as long as the current actual value is outside the valid target window. The arrow direction indicates in which direction the shaft must be moved to reach the target window.

LED display:

With factory setting, the LED glows green as long as the actual value is within the programmed window. When leaving target window, the LED glows red. The shaft must be rotated in the direction of the glowing LED in order to arrive at the target value. The red glowing LED1 (left): counter-clockwise (ccw) rotation required. Red glowing LED2 (right): clockwise (cw) rotation required.

With factory settings, the LED display (see chapter 4.4) has the following meaning:

Operating state	LED	Meaning
There is no valid target value or no operating voltage.	Both LEDs inactive	No position monitoring active.
There is a valid target value.	Both LEDs green	The actual value is within the programmed target window.
	LED1 red	The actual value is outside the programmed target window. The axis must be rotated counterclockwise to reach the target window.
	LED2 red	The actual value is outside the programmed target window. The axis must be rotated clockwise to reach the target window.

Table 2: LED display

3.1.1.2 Loop positioning

NOTICE	Target window is also applied to the loop length.
---------------	---

NOTICE	The behavior of the clearance compensation is independent of the set counting direction of the display. The loop type must be changed to change the clearance compensation.
---------------	---

If the position indicator is operated on a spindle or an additional gear, the spindle or external gear backlash can be compensated by means of loop positioning. Therefore, movement towards the target value is always in the same direction. This direction of approach can be defined.

Example:

Each target position should be approached with a clockwise rotation (CW) of the shaft.

- Case 1 ⇒ the new position is greater than actual value:
The target position is approached directly clockwise (CW).
- **Case 2** ⇒ the new position is smaller than actual value:
The directional arrows of the position indicator indicate that the loop length is to be moved counterclockwise (CCW) beyond the target position. Then the target value is approached clockwise.

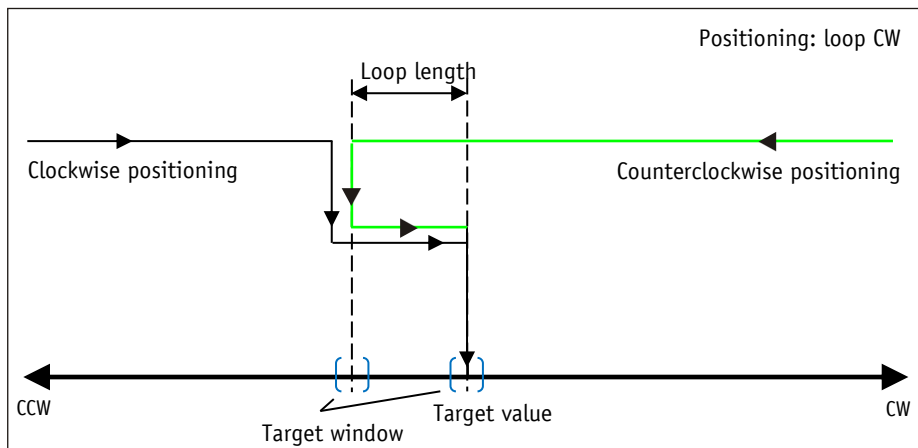

Fig. 4: Positioning loop CW

3.1.1.3 ControlWord in Absolute Position operating mode

The ControlWord differs in function depending on operating mode.

The designation of the individual bits of the ControlWord as well as their meaning:

Bit	Meaning	Value = 0	Value = 1
0	bc00_CalibrationExecute	-	Trigger calibration (edge controlled, positive)
1	bc01_Reserved	ever 0	-
2	bc02_Reserved	ever 0	-
3	bc03_DisplayRange	Normal display area	Extended display area
4	bc04_GuardingBit	is mirrored in StatusWord	is mirrored in StatusWord
5	bc05_ErrorAck	-	Acknowledge error
6	bc06_Reserved	ever 0	-

Bit	Meaning		Value = 0	Value = 1
7	bc07_Reserved		ever 0	-
8	bc08_Reserved		ever 0	-
9	bc09_TargetValueActive		-	Activate target value
10	bc10_Reserved		ever 0	-
11	bc11_Led1Green	Release via LED parameters required	Deactivate LED	Activate LED
12	bc12_Led1Red		Deactivate LED	Activate LED
13	bc13_Led2Green		Deactivate LED	Activate LED
14	bc14_Led2Red		Deactivate LED	Activate LED
15	bc15_LedBlinking		Deactivate LED	Activate LED

Table 3: ControlWord in Absolute Position operating mode

3.1.1.4 StatusWord in Absolute Position operating mode

The Status Word shows the current status of the AP10.

The designation of the individual bits of the StatusWord as well as their meaning:

Bit	Meaning	Value = 0	Value = 1
0	bs00_DirIndicationCW	Target value can be reached counterclockwise or in negative direction	Target value can be reached clockwise or in positive direction
1	bs01_DirIndicationCCW	Target value can be reached clockwise or in positive direction	Target value can be reached counterclockwise or in negative direction
2	bs02_CalibrationExecuted	No calibration is currently being carried out	A calibration is currently being carried out
3	bs03_Reserved	ever 0	-
4	bs04_GuardingBit	mirrored from ControlWord	mirrored from ControlWord
5	bs05_TargetWindowReached	Target window is not reached	Target window is reached
6	bs06_Deviation	Deviation Actual value \leq target value	Deviation Actual value $>$ target value
7	bs07_GeneralError	No error	There is an error
8	bs08_Reserved	ever 0	-
9	bs09_IncMeasurement	Increment measurement is deactivated	Increment measurement is activated
10	bs10_TargetValueState	Target value is not activated	Target value is activated
11	bs11_BatteryState	Battery Charging state is OK	Battery Charging state is critical
12	bs12_SpeedError	There is no SpeedError	There is a SpeedError
13	bs13_KeyConfiguration	Button is not pressed	Button is pressed
14	bs14_KeyCalibration	Button is not pressed	Button is pressed

Bit	Meaning	Value = 0	Value = 1
15	bs15_KeyIncremental	Button is not pressed	Button is pressed

Table 4: StatusWord in Absolute Position operating mode

3.1.2 Alpha-numeric display operating mode

Two 6-digit target values can be displayed in this operating mode. The target values are acknowledged by pressing the  button (see chapter 2.3).

Alpha-numeric display:

Both lines are freely writable. The content of the display line can be transmitted via the [DisplayData](#) parameter, and the content of the display line can be transmitted via the [TargetValue](#) parameter. In [ControlWord](#), the values must be switched to valid (see e. g. [bc09_TargetValueActive](#)) and the bits for data identification must be set correctly (see e. g. [bc07_TargetValueTypeSelect](#)). The data identifier is used to distinguish whether the data is interpreted and displayed as a number or as an alphanumeric character (ASCII) (see chapter 4.1.1, 4.1.3 and 4.1.5).

LCD display:

If there is no valid target value, the 1st display line is displayed blank. "----" appears in the 2nd display line.

A valid target value is displayed flashing until its receipt is acknowledged. If neither target value has been acknowledged, both values are acknowledged jointly by pressing the  key. Acknowledgment can also take place via the corresponding control bit via the interface.

LED display:

Status LED1 and LED2:

With factory settings, the LED display (LED1, LED2) works according to the following table.

Operating state	State	Meaning
There is no valid target value.	Both LEDs off	
There is a valid target value.	LED1 red	Display data not acknowledged
	LED1 green	Display data acknowledged
	LED2 red	Target value not acknowledged
	LED2 green	Target value acknowledged

Table 5: Status LED display in the alpha-numeric display operating mode

3.1.2.1 ControlWord: Alpha-numeric display

The ControlWord differs in function depending on operating mode.

The designation of the individual bits of the ControlWord as well as their meaning:

Bit	Meaning	Value = 0	Value = 1
0	bc00_Reserved	ever 0	-

Bit	Meaning	Value = 0	Value = 1
1	bc01_Reserved	ever 0	-
2	bc02_DisplayDataActive (display line 1)	-	Activate upper line display
3	bc03_DisplayRange	Normal display area	Extended display area
4	bc04_GuardingBit	is mirrored in StatusWord	is mirrored in StatusWord
5	bc05_ErrorAck	-	Acknowledge error
6	bc06_TargetValueAckMode (display line 2)	Manually acknowledge target value	Acknowledge target value
7	bc07_TargetValueTypeSelect (display line 2)	Interpret target value as a number	Interpret target value as ASCII character
8	bc08_DisplayDataTypeSelect (display line 1)	Interpret display data as a number	Interpret display data as ASCII character
9	bc09_TargetValueActive (display line 2)	-	Activate bottom line display
10	bc10_DisplayDataAckMode (display line 1)	Manually acknowledge target value	Acknowledge target value
11	bc11_Led1Green	Release via LED parameters required	Deactivate LED
12	bc12_Led1Red		Deactivate LED
13	bc13_Led2Green		Deactivate LED
14	bc14_Led2Red		Deactivate LED
15	bc15_LedBlinking		Deactivate LED
			Activate LED

Table 6: ControlWord alpha-numeric display operating mode

3.1.2.2 StatusWord: Alpha-numeric display

The Status Word shows the current status of the AP10.



The designation of the individual bits of the StatusWord as well as their meaning:

Bit	Meaning	Value = 0	Value = 1
0	bs00_Reserved	ever 0	-
1	bs01_Reserved	ever 0	-
2	bs02_DisplayDataActive (display line 1)	DisplayData is not activated	DisplayData is activated
3	bs03_TargetValueAck (display line 2)	Target value not acknowledged	Target value acknowledged
4	bs04_GuardingBit	mirrored from ControlWord	mirrored from ControlWord
5	bs05_DisplayDataAck (display line 1)	DisplayData not acknowledged	DisplayData acknowledged
6	bs06_Reserved	ever 0	-
7	bs07_GeneralError	No error	An error exists
8	bs08_DisplayDataType (display line 1)	DisplayData are interpreted as a number	DisplayData are interpreted as an ASCII character

Bit	Meaning	Value = 0	Value = 1
9	bs09_TargetValueType (display line 2)	Target value is interpreted as a number	Target value is interpreted as an ASCII character
10	bs10_TargetValueState (display line 2)	Target value is not activated	Target value is activated
11	bs11_BatteryState	Battery Charging state is OK	Battery Charging state is critical
12	bs12_SpeedError	There is no SpeedError	There is a SpeedError
13	bs13_KeyConfiguration	Button is not pressed	Button is pressed
14	bs14_KeyCalibration	Button is not pressed	Button is pressed
15	bs15_KeyIncremental	Button is not pressed	Button is pressed

Table 7: StatusWord alpha-numeric display operating mode

3.2 Battery buffering

Without an external power supply, encoder changes are recorded with battery support. Depending on the duration of battery operation (including storage) and the frequency of adjustments without an external power supply, the battery life is approximately 8 years. Battery voltage is checked at intervals of approx. 10 min. If battery voltage drops below a specified value, the battery symbol  will blink on the display. If the battery voltage continues to drop,  will be displayed permanently. The battery should be replaced within approx. three months after the first appearance of the battery symbol. For battery replacement it is mandatory to follow the instructions of the installation instructions. Replacement can also take place at the SIKO distribution partners or in the SIKO main plant.

Behavior of the StatusWord:

The charge status of the battery is signified in the StatusWord. In the case of a critical charging voltage, bs11_BatteryState is set, and in the case of an empty or non-existing battery, a fault is additionally signaled with bs07_GeneralError.

3.3 Parameterization of the position indicator

The position indicator can be fully parameterized via the IO-Link interface. All parameters can also be set manually with the help of the keyboard.



3.3.1 Manual parameterization

3.3.1.1 Starting parameterization

The time until menu release is displayed when the  button is pressed. Parameterization starts if it is actuated for the duration of the enable time (see chapter 2.3 and 4.5.1).

3.3.1.2 Value input

NOTICE	When you enter values via the keys, the display range is limited to -199999 ... 999999. If values beyond this range are entered via the interface, "FULL" will be displayed when the parameter is called up.
---------------	--



Enter values via the  key and the  key.
Confirm values entered by pressing the  key.

 - decimal place selection key

 - value input key

3.3.1.3 Value selection

For some parameters you can select values from a list. Direct value input is not possible there.

Pressing the  key, the value can be selected from the list. By pressing the  key, the selection is confirmed.

3.3.1.4 Overview of the operating menu

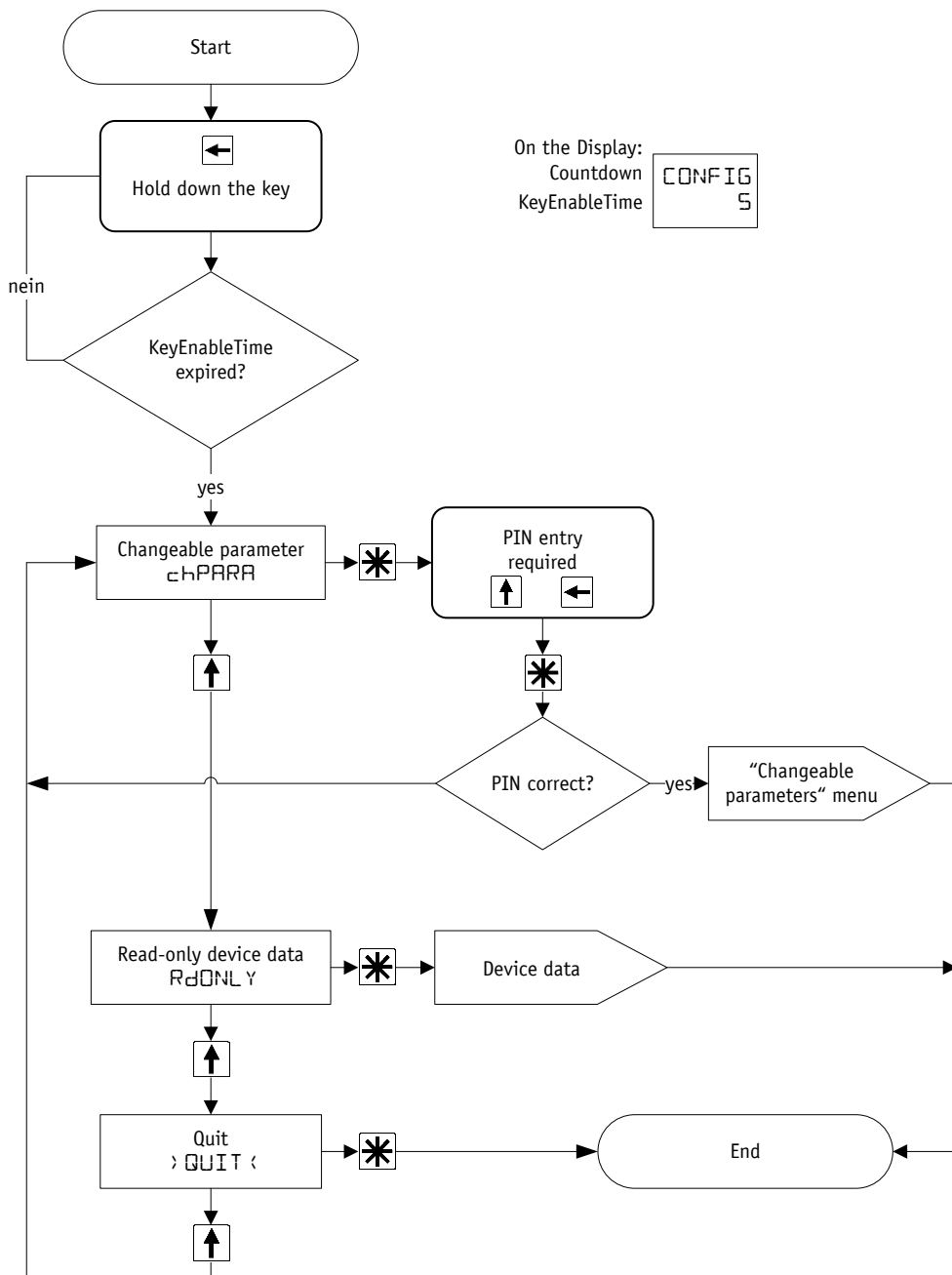

Fig. 5: Menu selection

3.3.1.5 "Changeable parameters" menu

The "Changeable parameters" menu is structured as follows:

Description	Display	Page
Positioning	POSI	17
Visualization	VISUAL	17
LED function	LEDS	17

Description	Display	Page
Device options	OPTION	18

Table 8: "Changeable parameters" menu structure

3.3.1.6 Positioning

The following parameters can be set in the "Positioning" menu:

Description	Display	Chapter
Resolution	RESOL	4.2.1
DecimalPlaces	DEC PL	4.2.2
DisplayDivisor	DISDIV	4.2.3
CountingDirection	CNT DIR	4.2.4
CalibrationValue	CALVAL	4.2.5
Calibration selection	CALVAL YES NO	3.4
TargetWindow	TW	4.2.6
LoopType	LOOP	4.2.7
LoopLength	LOOP L	4.2.8

Table 9: "Positioning" menu

3.3.1.7 Visualization

The following parameters can be set in the "Visualization" menu:

Description	Display	Chapter
DisplayOrientation	DISPL	4.3.1

Table 10: "Visualization" menu

3.3.1.8 LED function

The following parameters can be set in the "LED function" menu:

Description	Display	Chapter
Led1GreenMode	LED 1GN	4.4.2
Led2GreenMode	LED 2GN	4.4.3
Led1RedMode	LED 1RD	4.4.4
Led2RedMode	LED 2RD	4.4.5
ActiveLedsFlashing	LED FL	4.4.6

Table 11: "LED function" menu

3.3.1.9 Device options

The following parameters can be set in the "Additional device options" menu:

Description	Display	Chapter
KeyEnableTime	K TIME	4.5.1
KeyCalibration	K CAL	4.5.2
KeyIncremental	K INC	4.5.3
OperatingMode	OPMODE	4.5.4
PINChange	PIN	4.5.6
LoadDefault	LOAD P	4.5.7
CODE	CODE	4.5.8

Table 12: "Additional device options" menu

3.3.2 Parameterization via interface

The position indicator can be completely parameterized in the IO-Link interface (see chapter [5.2](#)).

3.4 Calibration

NOTICE	Calibration is only possible if the chain dimension is not active and the actual value is not 0.
---------------	--

Two steps are required for executing calibration:

- Write calibration value: Parameter CalibrationValue (see chapter [4.2.5](#)).
- Execute calibration (using operating keys, see chapter [2.3](#) or SystemCommand see chapter [5.3](#) or ControlWord see chapter [5.1.1.1](#)).

Since the measuring system is an absolute system, calibration is necessary only once with commissioning. With calibration, the CalibrationValue is adopted for calculation of the actual value. The following equation is applied in case (time) of calibration:

- Actual value = $\text{ActualValue} = 0 + \text{CalibrationValue}$

3.5 Additional functions

3.5.1 Device data

The following values can be read in the "Read Only" menu:

Description	Display	Chapter
Voltage of Battery	UBATT	
Actual CalibrationValue	CALACT	4.2.5
Firmware Revision	VERSION	5.2.1

Table 13: "Device data" menu

3.5.2 Restore factory settings

There are various options for restoring the factory settings of the device:

Access	Coding		Factory settings are restored
Manual	CODE (see chapter 4.5.8)	011100	all parameters
	Load Default (see chapter 4.5.7)	ALL	all parameters
Interface	SystemCommands (see chapter 5.3)	130 (82h)	all parameters

Table 14: Access to factory settings

3.6 Warnings / Errors

3.6.1 Warnings

Warnings have no influence on the recording of the actual value. Warnings are deleted after removing the cause.

Possible warnings:

- Battery voltage for absolute position detection is below limit ⇒ immediately exchange battery!
This warning is displayed with a blinking battery symbol. Warning messages are output via the interface via the StatusWord (see chapter 3.5.1 and chapter 5.1.1.2). The cause of the warning can be determined using the event code (see chapter 5.5).



Display	Bit assignment in the StatusWord	Error
 flashing	bs11_BatteryState	Low battery voltage (critical) PositionValue is still valid!

Table 15: Warnings

3.6.2 Errors

NOTICE	Calibration may also be required Depending on the error type.
---------------	---

Error states are signaled via display (written in red or battery symbol) and interface. The cause of the fault can be determined using the event or error code (see chapter 5.5 and 5.6). To return to normal operation, the cause must be removed (see Table 16). Error signaling can then be acknowledged or deleted with the  key (see chapter 2.3).

(For signaling see chapter 2.1.)

Display	Bit assignment in the StatusWord	Error
<input type="checkbox"/> permanent	bs11_BatteryState + bs07_GeneralError	Battery undervoltage (dead)
SPEED	bs12_SpeedError + bs07_GeneralError	Travel speed exceeded

Table 16: Error messages

3.6.3 Corrective actions

Display	Error	Possible effect	Corrective actions
<input type="checkbox"/> permanent	Battery empty	Actual value not reliable	Battery change + calibration travel
SPEED	Permissible speed exceeded (see installation instruction)	Actual value not reliable	Traversing speed + calibration travel

Table 17: Corrective actions

4 Parameter

All parameters stored in the EEPROM can be reset to factory default settings if necessary (see chapter 3.5.2).

Chapter	Starting with page
Process data	20
Positioning	22
Visualization	27
LEDs	27
Device options	30

4.1 Process data

4.1.1 ControlWord

General characteristics

EEPROM	no
Unit	-
Value range	see chapter 5.1
Default	0

IO-Link

Data type	UnsignedInteger16		
Access	wo		
Index	-	Sub-index	-
Data Storage	no		

4.1.2 StatusWord

General characteristics

EEPROM	no
Unit	-
Value range	see chapter 5.1
Default	0

IO-Link

Data type	UnsignedInteger16		
Access	ro		
Index	70	Sub-index	0
Data Storage	no		

4.1.3 TargetValue

General characteristics

EEPROM	no
Unit	-

IO-Link

Data type	SignedInteger32		
Access	rw		
Index	69	Sub-index	0
Data Storage	no		
Value range	-2147483648 ... 2147483647		
Default	0		

Display

Value range	-199999 ... 999999
-------------	--------------------

4.1.4 ActualValue

General characteristics

EEPROM	no
Unit	-

IO-Link

Data type	SignedInteger32		
Access	ro		
Index	68	Sub-index	0
Data Storage	no		
Value range	-2147483648 ... 2147483647		
Default	0		

Display

Value range	-199999 ... 999999
-------------	--------------------

4.1.5 DisplayData

General characteristics

EEPROM	no
Unit	-
Value range	6 character
Default	-

IO-Link

Data type	OctetString6		
Access	rw		
Index	95	Sub-index	0
Data Storage	no		

4.1.6 TargetValueLeft

General characteristics

EEPROM	no
Unit	-
Value range	2 character
Default	-

IO-Link

Data type	OctetString2		
Access	rw		
Index	-	Sub-index	-
Data Storage	no		

4.2 Positioning

4.2.1 Resolution

General characteristics

EEPROM	yes
Unit	-
Value range	1 ... 999999
Default	880

IO-Link

Data type	UnsignedInteger32		
Access	rw		
Index	72	Sub-index	0
Data Storage	yes		

Display

Menu	cHPARAM \ POSI \ RESOL
------	------------------------

4.2.2 DecimalPlaces

General characteristics

EEPROM	yes
Unit	-
Value range	0 ... 4
Default	0

IO-Link

Data type	UnsignedInteger8		
Access	rw		
Index	73	Sub-index	0
Data Storage	yes		

Display

Menu	cHPARAM \ POSI \ DEC PL
------	-------------------------

Parameter selection

Value	Display	Description
0	0	0
1	0.1	1 decimal place
2	0.12	2 decimal places
3	0.123	3 decimal places
4	0.1234	4 decimal places

4.2.3 DisplayDivisor

General characteristics

EEPROM	yes
Unit	-
Value range	0 ... 3
Default	0

IO-Link

Data type	UnsignedInteger8		
Access	rw		
Index	74	Sub-index	0
Data Storage	yes		

Display

Menu	⌘hPARAM \ POSI \ DISDIV
------	-------------------------

Parameter selection

Value	Display	Description
0	1	Division by 1
1	10	Division by 10
2	100	Division by 100
3	1000	Division by 1000

4.2.4 CountingDirection

General characteristics

EEPROM	yes
Unit	-
Value range	0 ... 1
Default	0

IO-Link

Data type	UnsignedInteger8 / Bool		
Access	rw		
Index	76	Sub-index	0
Data Storage	yes		

Display

Menu	⌘hPARAM \ POSI \ Cn+DIR
------	-------------------------

Parameter selection

Value	Display	Description
0	CW	Sense of rotation i Increasing actual values with clockwise rotation
1	CCW	Sense of rotation e Increasing actual values with counterclockwise rotation

4.2.5 CalibrationValue

General characteristics

EEPROM	yes
Unit	-
Value range	-999999 ... 999999
Default	0

IO-Link

Data type	SignedInteger32		
Access	rw		
Index	77	Sub-index	0
Data Storage	yes		

Display

Menu	cHPARAM \ POSI \ CALVAL
------	-------------------------

4.2.6 TargetWindow

General characteristics

EEPROM	yes
Unit	User units
Value range	0 ... 9999
Default	5

IO-Link

Data type	UnsignedInteger16		
Access	rw		
Index	78	Sub-index	0
Data Storage	yes		

Display

Menu	cHPARAM \ POSI \ TW
------	---------------------

4.2.7 LoopType

General characteristics

EEPROM	yes
Class	S
Unit	-
Value range	0 ... 2
Default	0

IO-Link

Data type	UnsignedInteger8		
Access	rw		
Index	79	Sub-index	0
Data Storage	yes		

Display

Menu	cHPARAM \ POSI \ LOOP
------	-----------------------

Parameter selection

Value	Display	Description
0	DIRECT	The target value is approached directly from the current position.
1	POS	To compensate for the spindle play, the target value is always approached in the positive direction.
2	NEG	To compensate for the spindle play, the target value is always approached in the negative direction.

4.2.8 LoopLength

General characteristics

EEPROM	yes
Unit	-
Value range	0 ... 9999
Default	0

IO-Link

Data type	UnsignedInteger16		
Access	rw		
Index	80	Sub-index	0
Data Storage	yes		

Display

Menu	cHPARAM \ POSI \ LOOP L
------	-------------------------

4.3 Visualization

4.3.1 DisplayOrientation

General characteristics

EEPROM	yes
Unit	-
Value range	0 ... 1
Default	0

IO-Link

Data type	UnsignedInteger8/Bool		
Access	rw		
Index	83	Sub-index	0
Data Storage	yes		

Display

Menu	chPARAM \ VISUAL \ DISPL
------	--------------------------

Parameter selection

Value	Display	Description
0	☐	Orientation 0°
1	180☐	Orientation 180°

4.4 LEDs

4.4.1 LEDMode

General characteristics

EEPROM	yes
Unit	-
Value range	0 ... see subindexes
Default	15

IO-Link

Data type	UnsignedInteger8		
Access	rw		
Index	86	Sub-index	0
Data Storage	yes		

4.4.2 Led1GreenMode

General characteristics

EEPROM	yes
Unit	-
Value range	0 ... 1
Default	1

IO-Link

Data type	Bool		
Access	rw		
Index	86	Sub-index	1
Data Storage	yes		

Display

Menu	cHPARAM \ LE D5 \ LE D 1GN
------	----------------------------

Parameter selection

Value	Display	Description
0	OFF	Depending on the ControlBit
1	ON	Depending on the device status (see chapter 3.1)

4.4.3 Led2GreenMode

General characteristics

EEPROM	yes
Unit	-
Value range	0 ... 1
Default	1

IO-Link

Data type	Bool		
Access	rw		
Index	86	Sub-index	2
Data Storage	yes		

Display

Menu	cHPARAM \ LE D5 \ LE D 2GN
------	----------------------------

Parameter selection

Value	Display	Description
0	OFF	Depending on the ControlBit
1	ON	Depending on the device status (see chapter 3.1)

4.4.4 Led1RedMode

General characteristics

EEPROM	yes
Unit	-
Value range	0 ... 1
Default	1

IO-Link

Data type	Bool		
Access	rw		
Index	86	Sub-index	3
Data Storage	yes		

Display

Menu	cHPARAM \ LEIS \ LEI1RD
------	-------------------------

Parameter selection

Value	Display	Description
0	OFF	Depending on the ControlBit
1	ON	Depending on the device status (see chapter 3.1)

4.4.5 Led2RedMode

General characteristics

EEPROM	yes
Unit	-
Value range	0 ... 1
Default	1

IO-Link

Data type	Bool		
Access	rw		
Index	86	Sub-index	4
Data Storage	yes		

Display

Menu	cHPARAM \ LEIS \ LEI2RD
------	-------------------------

Parameter selection

Value	Display	Description
0	OFF	Depending on the ControlBit
1	ON	Depending on the device status (see chapter 3.1)

4.4.6 ActiveLedsFlashing

General characteristics

EEPROM	yes
Unit	-
Value range	0 ... 1
Default	1

IO-Link

Data type	Bool		
Access	rw		
Index	86	Sub-index	5
Data Storage	yes		

Display

Menu	cHPARAM \ LEIS \ LED FL
------	-------------------------

Parameter selection

Value	Display	Description
0	OFF	Depending on the ControlBit (see bc15_LedBlinking)
1	ON	Depending on the device status (see chapter 3.1)

4.5 Device options

4.5.1 KeyEnableTime

General characteristics

EEPROM	yes
Unit	s

IO-Link

Data type	-		
Access	No access		
Index	-	Sub-index	-
Data Storage	-		

Display

Menu	cHPARAM \ OPTION \ K TIME
Value range	1 ... 60
Default	5

4.5.2 KeyCalibration

General characteristics

EEPROM	yes
Unit	-
Value range	0 ... 1
Default	1

IO-Link

Data type	UnsignedInteger8 / Bool		
Access	rw		
Index	88	Sub-index	0
Data Storage	yes		

Display

Menu	cHPARAM\OPTION\K CAL
------	----------------------

Parameter selection

Value	Display	Description
0	OFF	Functions disabled via key
1	ON	Functions enabled via key

4.5.3 KeyIncremental

General characteristics

EEPROM	yes
Unit	-
Value range	0 ... 1
Default	1

IO-Link

Data type	UnsignedInteger8 / Bool		
Access	rw		
Index	89	Sub-index	0
Data Storage	yes		

Display

Menu	cHPARAM\OPTION\K INC
------	----------------------

Parameter selection

Value	Display	Description
0	OFF	Functions disabled via key
1	ON	Functions enabled via key

4.5.4 OperatingMode

General characteristics

EEPROM	yes
Unit	-
Value range	0 ... 1
Default	0

IO-Link

Data type	UnsignedInteger8		
Access	rw		
Index	92	Sub-index	0
Data Storage	yes		

Display

Menu	cHPARAM \ OPTION \ OPMODE
------	---------------------------

Parameter selection

Value	Display	Description
0	ABS	Absolute position
1	DISPL	Alpha-numeric display

4.5.5 SensorType

General characteristics

EEPROM	yes
Unit	-
Value range	2 ... 2
Default	2

IO-Link

Data type	UnsignedInteger8		
Access	rw		
Index	93	Sub-index	0
Data Storage	yes		

Parameter selection

Value	Description
2	Internal sensor

4.5.6 PINChange

PIN required to change parameters via buttons and display.

General characteristics

EEPROM	yes
Unit	-
Value range	0 ... 999999
Default	0

IO-Link

Data type	UnsignedInteger32		
Access	rw		
Index	67	Sub-index	0
Data Storage	yes		

Display

Menu	cHPARAM \ OPTION \ PIN
------	------------------------

4.5.7 LoadDefault

General characteristics

EEPROM	yes
Unit	-

Display

Menu	cHPARAM \ OPTION \ LOADP
------	--------------------------

Parameter selection

Value	Display	Description
0	NO	No function
1	ALL	Reset all parameters to factory settings

4.5.8 CODE

General characteristics

EEPROM	no
Unit	-

Display

Menu	cHPARAM \ OPTION \ CODE
------	-------------------------

Parameter selection

Value	SystemCommand	Description
0	-	No function
11100	130	Reset all parameters to factory settings

5 IO-Link

The device description is available for download as IODD at www.siko-global.com and in the IODD finder of the IO-Link Community.

IO-Link Version	V1.1
SIO-Mode	No
Port	Class A
COM-Mode	COM2 (38.4 kbaud)
Min Cycle Time	9.2 ms
Process Data In	8 Byte
Process Data Out	8 Byte
Data Storage	Yes
Block parameters	Yes

Table 18: General Interface Information

5.1 Process data input / output

All process data are displayed within 8 bytes and have different significance depending on the operating mode.

Transmission sequence:



Byte	0	1	2	3	4	5	6	7
Sub-index	18 ... 11	10 ... 3	2		1			
Bit offset	63 ... 56	55 ... 48	47 ... 40	39 ... 32	31 ... 24	23 ... 16	15 ... 8	7 ... 0

Table 19: Assignment of transfer sequence, sub-index and bit offset

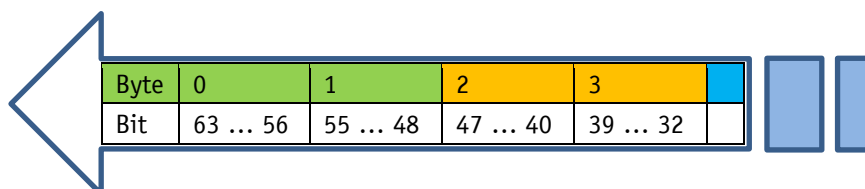

Fig. 6: Transmission sequence

Structure of Process Data				
Port	Name	Data Type	Address	
1	PDI_AbsoluteMode - bs08_Reserved	Bool	%I 1.0	
1	PDI_AbsoluteMode - bs09_IncrementalMeasurement	Bool	%I 1.1	
1	PDI_AbsoluteMode - bs10_TargetValueState	Bool	%I 1.2	
1	PDI_AbsoluteMode - bs11_BatteryState	Bool	%I 1.3	
1	PDI_AbsoluteMode - bs12_SpeedError	Bool	%I 1.4	
1	PDI_AbsoluteMode - bs13_KeyConfiguration	Bool	%I 1.5	
1	PDI_AbsoluteMode - bs14_KeyCalibration	Bool	%I 1.6	
1	PDI_AbsoluteMode - bs15_KeyIncremental	Bool	%I 1.7	
1	PDI_AbsoluteMode - bs00_IndicatorCW	Bool	%I 2.0	
1	PDI_AbsoluteMode - bs01_IndicatorCCW	Bool	%I 2.1	
1	PDI_AbsoluteMode - bs02_CalibrationExecuted	Bool	%I 2.2	
1	PDI_AbsoluteMode - bs03_Reserved	Bool	%I 2.3	
1	PDI_AbsoluteMode - bs04_GuardingBit	Bool	%I 2.4	
1	PDI_AbsoluteMode - bs05_TargetWindowReached	Bool	%I 2.5	
1	PDI_AbsoluteMode - bs06_Deviation	Bool	%I 2.6	
1	PDI_AbsoluteMode - bs07_GeneralError	Bool	%I 2.7	
1	PDI_AbsoluteMode - Reserved	Word	%IW 3	
1	PDI_AbsoluteMode - PositionValue	DInt	%ID 5	
1	PDI_AbsoluteMode - bs08_Reserved	Bool	%I 1.0	

Fig. 7: Example representation in IO-Link master

5.1.1 Process data in Absolute position operating mode

Sub-index	Significance (Absolute Position operating mode)		Bit offset	Octet	Length
	In (to master)	Out (from master)			
1	PositionValue	TargetValue	0	4 ... 7	32
2	Reserved	Reserved	32	2 ... 3	16
3 ... 18	StatusWord	ControlWord	48	0 ... 1	16

Table 20: Process data definition

5.1.1.1 Process data output (master ⇒ device)

Sub-index	Name	Bit offset	Bit length	Data type	Comment
1	TargetValue	0	32	Signed-Integer	Absolute target value
2	Reserved	32	16	-	Used in DisplayMode
3	bc00_CalibrationExecute	48	1	Bool	If true calibration becomes executed
4	bc01_Reserved	49	1	Bool	
5	bc02_Reserved	50	1	Bool	Used in DisplayMode
6	bc03_DisplayRange	51	1	Bool	If true display range is extended
7	bc04_GuardingBit	52	1	Bool	Communication guarding

Sub-index	Name	Bit offset	Bit length	Data type	Comment
8	bc05_ErrorAck	53	1	Bool	If true the actual error is acknowledged
9	bc06_Reserved	54	1	Bool	Used in DisplayMode
10	bc07_Reserved	55	1	Bool	Used in DisplayMode
11	bc08_Reserved	56	1	Bool	Used in DisplayMode
12	bc09_TargetValueActive	57	1	Bool	If true TargetValue is active
13	bc10_Reserved	58	1	Bool	
14	bc11_Led1Green	59	1	Bool	If true LED is on. Function controlled via Parameter LEDMode
15	bc12_Led1Red	60	1	Bool	see bc11
16	bc13_Led2Green	61	1	Bool	see bc11
17	bc14_Led2Red	62	1	Bool	see bc11
18	bc15_LedBlinking	63	1	Bool	If true LEDs are blinking when on

Table 21: Process data output in Absolute position operating mode

5.1.1.2 Process data input (device ⇒ master)

Sub-index	Name	Bit offset	Bit length	Data type	Comment
1	PositionValue	0	32	Signed-Integer	Absolute position value
2	Reserved	32	16	-	
3	bs00_DirIndicationCW	48	1	Bool	True if indicator cw is on
4	bs01_DirIndicationCCW	49	1	Bool	True if indicator ccw is on
5	bs02_CalibrationExecuted	50	1	Bool	True if calibration was executed by command via interface
6	bs03_Reserved	51	1	Bool	Used in DisplayMode
7	bs04_GuardingBit	52	1	Bool	Communication guarding
8	bs05_TargetWindowReached	53	1	Bool	True if target window is reached
9	bs06_Deviation	54	1	Bool	Deviation from actual value to target
10	bs07_GeneralError	55	1	Bool	True if error occurred
11	bs08_Reserved	56	1	Bool	Used in DisplayMode
12	bs09_IncMeasurement	57	1	Bool	True if incremental measurement is active
13	bs10_TargetValueState	58	1	Bool	True if target value is active

Sub-index	Name	Bit offset	Bit length	Data type	Comment
14	bs11_BatteryState	59	1	Bool	True if battery state is critical or low
15	bs12_SpeedError	60	1	Bool	True if max speed was exceeded
16	bs13_KeyConfiguration	61	1	Bool	True if key is actuated
17	bs14_KeyCalibration	62	1	Bool	True if key is actuated
18	bs15_KeyIncremental	63	1	Bool	True if key is actuated

Table 22: Process data input in Absolute position operating mode

5.1.2 Process data in Alphanumeric display operating mode

Sub-index	Significance (Alphanumeric display operating mode)		Bit offset	Octet	Length
	In (to master)	Out (from master)			
1	ActualValue	TargetValue	0	4 ... 7	32
2	Reserved	TargetValueLeft	32	2 ... 3	16
3 ... 18	StatusWord	ControlWord	48	0 ... 1	16

Table 23: Process data definition

5.1.2.1 Process data output (master ⇒ device)

Sub-index	Name	Bit offset	Bit length	Data type	Comment
1	TargetValue	0	32	Signed-Integer	Displayed value in bottom row (4 figures right)
2	TargetValueLeft	32	16	Unsigned Integer	Displayed value in bottom row (2 figures left)
3	bc00_Reserved	48	1	Bool	Used in AbsoluteMode
4	bc01_Reserved	49	1	Bool	If true DisplayData is active
5	bc02_DisplayDataActive	50	1	Bool	
6	bc03_DisplayRange	51	1	Bool	If true display range is extended
7	bc04_GuardingBit	52	1	Bool	Communication guarding
8	bc05_ErrorAck	53	1	Bool	If true the actual error is acknowledged
9	bc06_TargetValueAckMode	54	1	Bool	If true TargetValue becomes acknowledged
10	bc07_TargetValueTypeSelect	55	1	Bool	Format of TargetValue
11	bc08_DisplayDataTypeSelect	56	1	Bool	Format of DisplayData
12	bc09_TargetValueActive	57	1	Bool	If true TargetValue is active

Sub-index	Name	Bit offset	Bit length	Data type	Comment
13	bc10_DisplayDataAckMode	58	1	Bool	If true DisplayData becomes acknowledged
14	bc11_Led1Green	59	1	Bool	If true LED is on. Function controlled via Parameter LEDMode
15	bc12_Led1Red	60	1	Bool	see bc11
16	bc13_Led2Green	61	1	Bool	see bc11
17	bc14_Led2Red	62	1	Bool	see bc11
18	bc15_LedBlinking	63	1	Bool	If true LEDs are blinking when on

Table 24: Process data output in Alphanumeric display operating mode

5.1.2.2 Process data input (device ⇒ master)

Sub-index	Name	Bit offset	Bit length	Data type	Comment
1	PositionValue	0	32	Signed-Integer	Absolute position value
2	Reserved	32	16	-	
3	bs00_Reserved	48	1	Bool	Used in AbsoluteMode
4	bs01_Reserved	49	1	Bool	Used in AbsoluteMode
5	bs02_DisplayDataActive	50	1	Bool	True if DisplayData is active
6	bs03_TargetValueAck	51	1	Bool	True if TargetValue is acknowledged
7	bs04_GuardingBit	52	1	Bool	Communication guarding
8	bs05_DisplayDataAck	53	1	Bool	True if DisplayData is acknowledged
9	bs06_Reserved	54	1	Bool	Used in AbsoluteMode
10	bs07_GeneralError	55	1	Bool	True if error occurred
11	bs08_DisplayDataType	56	1	Bool	Format of DisplayData
12	bs09_TargetValueType	57	1	Bool	Format of TargetValue
13	bs10_TargetValueState	58	1	Bool	True if TargetValue is active
14	bs11_BatteryState	59	1	Bool	True if battery state is critical or low
15	bs12_SpeedError	60	1	Bool	True if speed limit is violated
16	bs13_KeyConfiguration	61	1	Bool	True if key is actuated
17	bs14_KeyCalibration	62	1	Bool	True if key is actuated
18	bs15_KeyIncremental	63	1	Bool	True if key is actuated

Table 25: Process data input in Alphanumeric display operating mode

5.2 Directory of objects

5.2.1 IO-Link specific objects

Index (hex)	Name	Type	Length	Access	Default	Comment
0 (00h)	DirectParameter1	Record	16 Byte	rw		See IO-Link Interface Spec.
1 (01h)	DirectParameter2	Record	16 Byte	rw		See IO-Link Interface Spec.
2 (02h)	SystemCommands			wo		See IO-Link Interface Spec. and 5.3
3 (03h)	DataStorageIndex	Record	72 Byte	ro		See IO-Link Interface Spec.
12 (0Ch)	DeviceAccesLocks	Record	2 Byte	wr		See IO-Link Interface Spec. and 5.4
13 (0Dh)	ProfileCharacteristic	Record	2 Byte	ro		See IO-Link Interface Spec.
14 (0Eh)	PDInputDescriptor	Unsigned Integer16	3 Byte	ro		See IO-Link Interface Spec.
15 (0Fh)	PDOOutputDescriptor	Unsigned Integer16	3 Byte	ro		See IO-Link Interface Spec.
16 (10h)	VendorName	String	9 Byte	ro	SIKO GmbH	
17 (11h)	VendorText	String	19 Byte	ro	www.siko-global.com	
18 (12h)	ProduktName	String	6 Byte	ro	_AP10_	
19 (13h)	ProduktID	String	1 Byte	ro	1	
20 (14h)	ProduktText	String	37 Byte	ro	Absolute position indicator rotative	
21 (15h)	SerialNumber	String	7 Byte	ro	xxxxxxx	
22 (16h)	HardwareRevision	String	13 Byte	ro	89687LpxIx/Jx	
23 (17h)	FirmwareRevision	String	9 Byte	ro	FW-_V200_	
24 (18h)	ApplicationSpecific Tag	String	32 Byte	rw	***	See IO-Link Interface Spec.
36 (24h)	DeviceStatus	Uint	1 Byte	ro		See IO-Link Interface Spec.

Table 26: IO-Link specific indexes

5.3 SystemCommands

Index (hex)	Name	Access	Value	Name	Comment
2 (02h)	SystemCommands	wo	1	ParamUploadStart	IO-Link Spec.
			2	ParamUploadEnd	
			3	ParamDownloadStart	
			4	ParamDownloadStart	
			5	ParamDownloadStore	
			6	ParamBreak	
			128	Device Reset	
			130	Restore factory settings	
			161	Enable bootloader	Bootloading not via IO-Link
252	Execute calibration	see chapter 3.4			

Table 27: SystemCommands

5.4 DeviceAccessLocks

Index (hex)	Name	Access	Supported Access Locks	Comment
12 (0Ch)	DeviceAccessLocks	rw	Data Storage	IO-Link Spec.
			Local Parameterization	IO-Link Spec.

Table 28: DeviceAccessLocks

5.5 EventCodes

See also chapter [3.6.2](#).

Value	Name	Type	Comment
6145(1801h)	Speed error	Error	Travel speed exceeded
6146(1802h)	Battery empty	Error	Battery undervoltage (dead)
20498 (5012h)	Battery low	Warning	Charging state " critical"
25376 (6320h)	Parameter error	Error	IO-Link Spec.

Table 29: EventCodes

5.6 ErrorCodes

Value 1 st byte	Value 2 nd byte	Name	Comment
80	xx	Error Code	IO-Link Spec. V1.1.2 Annex D
81	xx	Vendor specific error code	
	00	Device application error, no details	
	11	Index not available	
	12	Subindex not available	
	20	Service temporarily not available	
	21	Service temporarily not available, local control	
	22	Service temporarily not available, device control	
	23	Write access denied	
	30	Parameter value out of range	
	31	Parameter value above limit	
	32	Parameter value below limit	
	33	Parameter length overrun	
	34	Parameter length underrun	
	35	Function not available	
	36	Function temporarily not available	
	40	Invalid parameter set	
	41	Inconsistent parameter set	
	82	Application not ready	

Table 30: Error codes

6 Block diagram

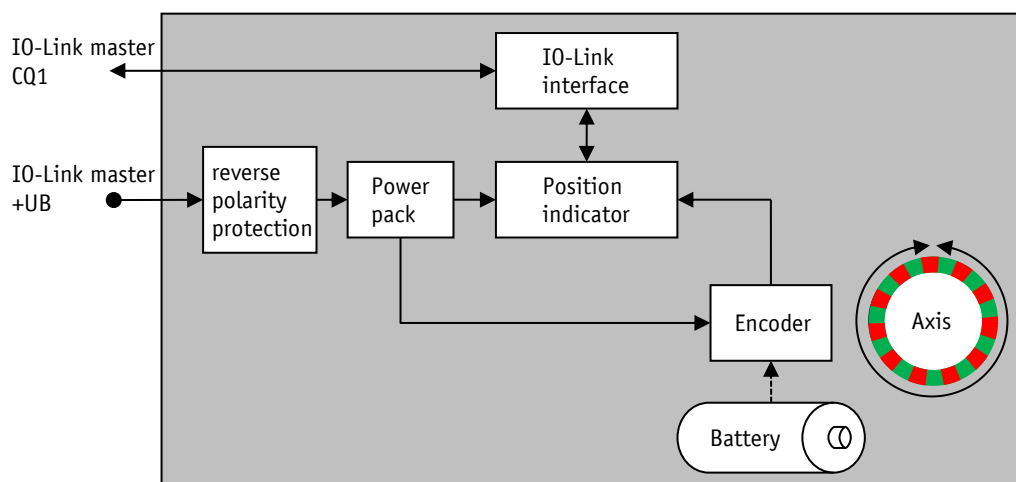

Fig. 8: Block diagram



SIKO GmbH

Weihermattenweg 2
79256 Buchenbach

Phone

+ 49 7661 394-0

Fax

+ 49 7661 394-388

E-Mail

info@siko-global.com

Internet

www.siko-global.com

Service

support@siko-global.com